

UPS OPERATING INSTRUCTIONS

AEG



PROTECT A.

PROTECT A. 500

PROTECT A. 700

Thank you for deciding to purchase the PROTECT A. UPS from AEG Power Solutions.

The following safety instructions are an important part of the operating instructions and will protect you against problems from operating errors and possible dangers. Please read these instructions carefully prior to commissioning!

1 **Notes on these Operating Instructions**

Duty to provide information

These operating instructions will help you to install and operate the Uninterruptible Power Supply (UPS), PROTECT A. 500 or PROTECT A. 700 - referred to as PROTECT A. in this document - safely and properly, and for its intended purpose. These operating instructions contain important information for avoiding dangers.

Please read these instructions carefully prior to commissioning!

These operating instructions are a composite part of PROTECT A.

The owner of this unit is obliged to communicate the full content of these operating instructions to all personnel transporting or starting the PROTECT A. or performing maintenance or any other work on the unit, without the information having to be requested.

Validity

These operating instructions comply with the current technical specifications of PROTECT A. at the time of publication. The contents do not constitute subject matter of the contract, but serve for information purposes only.

Warranty and liability

We reserve the right to alter any specifications given in these operating instructions, especially with regard to technical data and operation, prior to start-up or as a result of service work.

Claims in connection with supplied goods must be submitted within one week of receipt, along with the packing slip. Subsequent claims cannot be considered.

The warranty does not apply for damage caused by non-compliance with these instructions (such damage also includes damage to the warranty seal). AEG will accept no liability for consequential damage. AEG will rescind all

obligations such as warranty agreements, service contracts, etc. entered into by AEG or its representatives without prior notice in the event of maintenance and repair work being carried out with anything other than original AEG parts or spare parts purchased from AEG.

Handling

PROTECT A. is designed and constructed so that all necessary steps for start-up and operation can be performed without any internal manipulation of the unit. Maintenance and repair work may only be performed by trained and qualified personnel.

Illustrations are provided to clarify and facilitate certain steps.

If danger to personnel and the unit cannot be ruled out in the case of certain work, it is highlighted accordingly by pictographs explained in the safety regulations of chapter 3.

Hotline

If you still have questions after having read these operating instructions, please contact your dealer or our hotline:

Tel.: +49 (0) 1805 234 787

Fax: +49 (0) 1805 234 789

Internet: www.AEGpartnerNet.com

Copyright

No part of these operating instructions may be transmitted, reproduced and/or copied by any electronic or mechanical means without the express prior written permission of AEG.

© Copyright AEG 2008. All rights reserved.

Table of Contents

1	Notes on these Operating Instructions	4
2	System Overview	7
2.1	Brief Overview	7
2.2	Principle of Operation.....	8
3	Safety	10
3.1	General Safety Instructions	10
3.2	Safety Instructions for PROTECT A.	10
3.3	CE Certificate	14
3.4	Technical Data	15
4	Set-up.....	17
4.1	Unpacking and Inspection	17
4.2	Installation Site.....	18
4.3	Connections, Operating and Display Elements	19
5	Installation and Operation.....	20
5.1	Check	20
5.2	Installation	20
5.3	Charging.....	21
5.4	Connecting the Load (e.g. computer)	21
5.5	Modem/Phone Connection (data line protection).....	22
5.6	Communication Connection, Connection with USB or Serial Cable.....	22
5.7	Operation.....	23
5.7.1	Normal Operation.....	23
5.7.2	Battery Operation / Autonomous Operation	24
5.7.3	System Diagnosis / Fault Test	24
5.7.4	Shutdown and UPS Management Software.....	25
6	Displays and Troubleshooting	26
6.1	Warning Sounds.....	26
6.2	General Troubleshooting and Fault Rectification.....	26
7	Maintenance.....	28
7.1	Battery Replacement.....	29
8	Storage and Disposal	30
9	List of Terms.....	31
9.1	Technical Terminology	31

2 System Overview

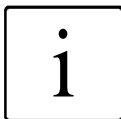

PROTECT A. is an **uninterruptible power supply** (UPS) for essential loads such as PCs, workstations, relatively small-scale telecommunication equipment and similar devices.

The PROTECT A. series is a compact, interactively operating UPS available with nominal power output ratings 500, 700, 1000 and 1400 VA.

This document describes both types, PROTECT A. 500 and PROTECT A. 700.

2.1 Brief Overview

LED display and a pushbutton switch are located on the front of the UPS for straightforward monitoring and operation. The display unit with traffic light function clearly signals the particular operating condition: normal operation, battery discharge, fault.

The connections for the mains and the loads are located on the rear of the PROTECT A., as are the communication interfaces and connections for telephone lines. Important UPS data is monitored permanently and transferred to the computer via USB or the RS232 interface and using the CompuWatch software.

Features of the PROTECT A.:

- ◆ VI (line – interactive) protection technology
- ◆ Automatic voltage regulation against mains voltage deviations (AVR)
- ◆ Microprocessor control for high reliability
- ◆ Modern battery management with integrated protection against exhaust. discharge and overloading
- ◆ User-friendly display with optimum legibility
- ◆ Intelligent monitoring system with USB and RS232 interfaces

- ◆ Overvoltage protection (RJ11) for fax, modem and phone
- ◆ CompuWatch software for shutdown, status messages and measurement values for all major operating systems (incl. Windows, Mac, Linux)
- ◆ Compact design / without fan

2.2 Principle of Operation

The UPS is connected to a shockproof socket between the public utility's mains and the loads to be protected.

Under normal operating conditions, i.e. if PROTECT A. is supplied with mains voltage, the battery charger will ensure that the battery is always completely charged.

During this operating status, the loads connected to PROTECT A. are supplied with voltage via mains filters which provide effective protection against mains voltage peaks and high-frequency faults.

In case of sustained mains undervoltage or overvoltage within defined ranges, the automatic voltage regulator (AVR) further stabilises the load voltage. As a result, voltage fluctuations in the public utility's mains are reduced to a level which is acceptable for the loads. This is performed without recourse to the internal energy storage, something which in turn has a positive effect on battery availability.

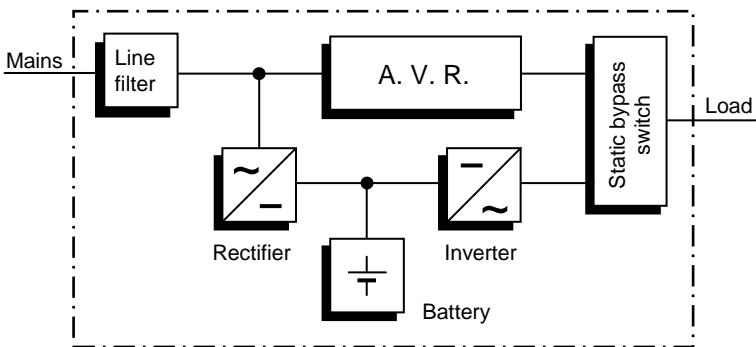

UPS Block diagram PROTECT A.

The static bypass switch is activated in the event of a mains failure. The inverter then takes over the voltage supply of the connected loads, in order to prevent the risk of data loss or damage to the loads. PROTECT A. supplies voltage until the battery is discharged or your IT system has been shut down and switched off properly.

The standby time mainly depends on the connected loads. If the mains power supply is back to normal values, the UPS will switch back the loads to mains supply. The battery charger will then recharge the battery.

For safety reasons (as required by German standards, VDE), the mains input in the unit will be disconnected by a two-pole switch in the event of a mains failure. Energy backfeed to the mains and voltage supply to the pins of the mains connector are thus reliably avoided.

Furthermore, additional measures ensure effective protection for the data/network interface.

3 Safety

3.1 General Safety Instructions

Read these operating instructions carefully prior to commissioning of the PROTECT A. UPS and observe the safety instructions!

Only use the unit if it is in a technically perfect condition and always in accordance with its intended purpose, while being aware of safety and danger aspects, and in accordance with the operating instructions! Immediately eliminate any faults that could be detrimental to safety.

The following pictograms are used in these operating instructions to identify dangers and important information:



Danger!

Identifies risk of fatal injury to the operator.



Attention!

Identifies risk of injury and risk of damage to the device and parts of the device.

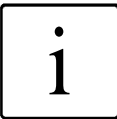

Information!

Useful and important information for operating the UPS.

3.2 Safety Instructions for PROTECT A.

This chapter contains important instructions for the PROTECT A. UPS. These must be followed during assembly, operation and maintenance of the uninterruptible power supply and the batteries.



The UPS is live, and the voltage can be dangerous. The unit may only be opened by trained and qualified personnel. Repairs may only be carried out by qualified customer service staff!



The output may be live, even if the UPS is not connected to the mains supply, as the UPS has its own internal power supply (battery)!



For health and safety reasons, the unit must be earthed correctly!

PROTECT A. may only be operated with or connected to a 220 / 230 / 240 VAC mains with protective grounding using a mains connection cable with PE conductor (included in the delivery) that has been tested in accordance with German standards (VDE).

Risk of burning!



The battery has powerful short-circuit currents. Incorrect connection or isolation faults can lead to melting of the plug connections, sparking potential and severe burns!



The unit has a warning signal that sounds when the battery voltage of PROTECT A. is exhausted or when the UPS is not working in its normal mode.



Observe the following safety instructions to ensure permanent operational safety of and safe work with the UPS:

- ◆ Do not dismantle the UPS!
- ◆ (The UPS does not contain any parts that require regular maintenance. Bear in mind that the warranty will be invalidated if the unit is opened!)
- ◆ Do not install the unit in direct sunshine or in close proximity of heaters!
- ◆ The unit is designed to be installed inside in heated rooms. Never install the UPS in the vicinity of water or in an excessively damp environment!

- ◆ Condensation may occur if the UPS is brought from a cold environment into the room where it is to be installed. The UPS must be absolutely dry prior to start-up. As a result, leave it to acclimatise for at least two hours.
- ◆ Never connect the mains input and the UPS output!
- ◆ Ensure that no fluids or foreign bodies can penetrate the UPS!
- ◆ Do not block the air vents of the unit! Make sure, for example, that children do not insert any objects in the ventilation openings!
- ◆ Do not connect household appliances such as hairdryers to the UPS!
- ◆ The mains connection should be near the unit and easily accessible to facilitate disconnecting the AC input or pulling out the plug!
- ◆ During operation, do not disconnect the mains connection cable from the UPS or from the socket outlet in the building (shockproof socket), otherwise the protective grounding of the UPS and all the loads connected to it will be cancelled.



Danger! Electric shocks!

Even after the mains voltage has been disconnected, the components within the UPS remain connected to the battery and can thus cause electric shocks. It is therefore imperative to disconnect the battery circuit before carrying out any maintenance or repair work!



If it is necessary to replace the battery or carry out maintenance work, this must be done by or under the supervision of a specialist familiar with batteries and the necessary safety precautions!

Only authorised persons are allowed in the vicinity of the batteries!

When replacing the battery, the following must be observed:
Only ever use an identical, maintenance-free sealed lead battery with the same data as the original battery.



Danger! Explosive!

Never throw batteries into open fire. Never open or damage batteries. (Electrolyte may leak out and damage skin and eyes. It may be toxic!)



Batteries can cause electric shocks and high short-circuit currents.

Therefore, take the following safety precautions when working with batteries:

- ◆ Take off watches, rings and other metallic objects!
- ◆ Only use tools with insulated handles!



For personal safety reasons, never switch on the main switch when the mains connector of PROTECT A. is disconnected!

3.3 CE Certificate

AEG

Power Solutions

Declaration of Conformity

Document - No. CE 0106

We

AEG Power Solutions GmbH
Emil – Siepmann – Straße 32, D – 59581 Warstein

declare under our sole responsibility that the product

Uninterruptible Power Supply (UPS)
Protect A.
type power 500VA / 700VA

to which this declaration relates is in conformity with the following standards or other normative documents

EN 62040-1-1:2003
EN 62040-2:2006 Class C2
EN 61000-3-2:2006
EN 61000-3-3:2005

Following the provisions of directives

2004 / 108 / EEC EMC- Directive
2006 / 95 / EEC Low Voltage Directive

Year of labelling the CE – Mark: 2008

Germany, 59581 Warstein, 2008-11-03

AEG Power Solutions GmbH
Quality Management

.....
(Filmar)

AEG Power Solutions GmbH
Product Management
Compact UPS

.....
(Schneider)

3.4 Technical Data

Type rating

PROTECT A. 500	500 VA / 300 W
PROTECT A. 700	700 VA / 420 W

UPS input

Nominal connection voltage	220 / 230 / 240 Vac
Voltage range without battery	170 Vac to 280 Vac
Frequency (automatic detection)	50 / 60 Hz
Connection	Non-heating appliance connector IEC 320 C 14

UPS output

Rated output voltage / AVR technology	230 Vac
Rated output voltage in battery operation	±10 %
Frequency in battery operation	50 Hz / 60 Hz ±1 Hz
Nominal output current	2.2 A (PROTECT A. 500) 3.0 A (PROTECT A. 700)
Changeover time in the event of a mains failure	2-6 ms (typical)
Type of voltage	approximated sine
Connection	4 non-heating appliance connectors IEC 320 C 13 with overvoltage protection, 3 with UPS back-up
Protection against over-temperature and short circuit	yes

Battery

Autonomy time at nominal load	2 min
Exhaustive discharge protection/ protection against excess load	yes

Charging time (to 90 % of rated capacity)	8 h
Type	Sealed, maintenance-free
PROTECT A. 500	Block battery 12 V / 7 Ah
e.g. CSB, type GP1272F2	3-5 years acc. to EUROBAT
Yuasa, type NP7-12D	Connection plug 6.3 mm
Panasonic, type LC-R127R2P (Faston 250)	
PROTECT A. 700	Block battery 12 V / 9 Ah
e.g. CSB, type HR1234WF2	3-5 years acc. to EUROBAT
Yuasa, type NPW7-12D	Connection plug 6.3 mm
Panasonic, type UP-RW1245P1 (Faston 250)	

Communication

Interfaces	USB and RS232
Shutdown software on CD	For all common operating systems, e.g. Windows, Linux, Mac, Unix, FreeBSD, Novell, Sun

General data

Inherent noise (1 m distance)	< 40 dB(A)
Operating temperature range	0 °C - 40 °C
Humidity	0 to 90 % (without condensation)
Installation height	Up to 1000 m at nominal output
Housing colour	Silver/black
Dimensions W x H x D [mm]	100 x 140 x 330
Weight [kg]	6 kg (PROTECT A. 500) 6.5 kg (PROTECT A. 700)
Cooling type	Increased natural air cooling
Storage temperature range	-15° C to +50° C (UPS electronics)
UPS with integrated battery	0 °C to +40 °C
Conformity	CE

Directives

The PROTECT A. meets the product standard EN 50091.

The CE mark on the unit confirms compliance with the EC outline directives for 73/23 EEC – Low voltage and for 89/336 EEC – Electromagnetic compatibility if the installation instructions described in the operating instructions are observed.

For 73/23 EEC low-voltage directive

Reference number EN 62040-1-1 : 2003

For 89/336 EMC directive

Reference number EN 50091-2 : 1995

EN 61000-3-2 : 1995

EN 61000-3-3 : 1995

4 Set-up

4.1 Unpacking and Inspection

The unit has been completely checked and inspected. Although the device has been packed and shipped with the usual degree of care, damage during transport cannot be ruled out completely.

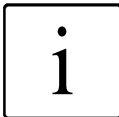

Claims for damage during transport must always be made with the transport company!

Check the shipping container for damage on arrival. If necessary, ask the transport company to check the goods and make a record of the damage in the presence of the transport company employee and report the damage to the AEG representative or dealer within eight days of delivery.

Check the content is complete:

- ◆ PROTECT A. with 500 or 700 VA
- ◆ Mains connection cable with shockproof plug acc. to CEE 7/7
Second mains connection cable with UK plug acc. to BS 1363
- ◆ Two device connecting cables
- ◆ USB / RS232 communication cable
- ◆ Management software "CompuWatch" on CD
- ◆ Operating instructions

Please contact our hotline (see page 5) in case of any discrepancy.

The original packaging provides effective protection against mechanical shocks and should be retained so the unit can be transported safely later on.



Please keep the plastic packaging bags away from babies and children in order to safeguard against suffocation accidents.

4.2 Installation Site

PROTECT A. is designed to be installed in a protected environment. When installing the unit, pay attention to such factors as sufficient ventilation and suitable ambient conditions.



PROTECT A. is air-cooled. Do not obstruct the air vents!

The UPS should preferably be operated at room temperature (between 15° C and 25° C).

Install the UPS in a room that is dry, relatively dust-free and free of chemical vapours.

Make sure that no magnetic storage media are stored and/or operated close to PROTECT A.



Check the nameplate to make sure the voltage and frequency data correspond to the values applicable to your loads.

4.3 Connections, Operating and Display Elements

Front

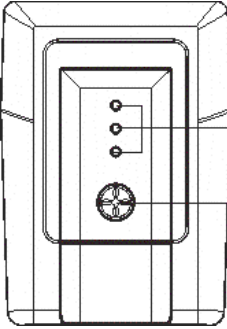

- 1 Main switch of the UPS
(mains switch)
- 2 LED displays:
Green LED: Mains/normal operation
Yellow LED: Battery operation
Red LED: Warning/fault,
battery renewal indication

Rear

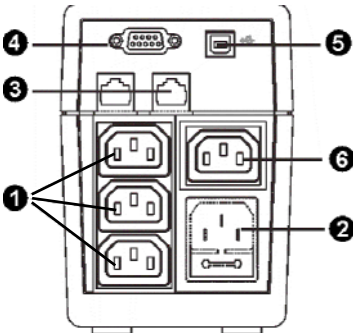

- 1 Load connections with
overvoltage protection and
UPS backup
- 2 Mains connection (UPS input)
with input fuse and integrated
back-up fuse
- 3 Data interface for modem/ fax/
phone (RJ11)
- 4 RS232 communication interface
(SUB-D 9-pin socket)
- 5 USB connection
- 6 Load connection with direct mains
supply (with overvoltage protection) –
without UPS back-up!

5 Installation and Operation

5.1 Check

Remove the UPS from its transport packaging and check that it has not been damaged in transit. If you find any damage, pack the unit up again and send it back to where you purchased it.

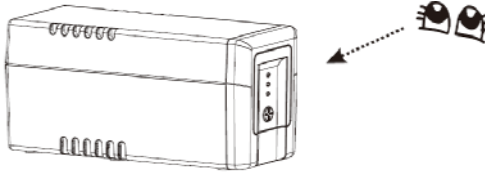

5.2 Installation

Install the UPS unit in a protected location where there is an adequate air supply and where it will be largely free from dust build-up, corrosive vapours and electrically conductive contamination.



Do not operate your UPS where it is exposed to high ambient temperatures or atmospheric humidity. Set up the UPS at least 20 cm away from the monitor in order to avoid interference.

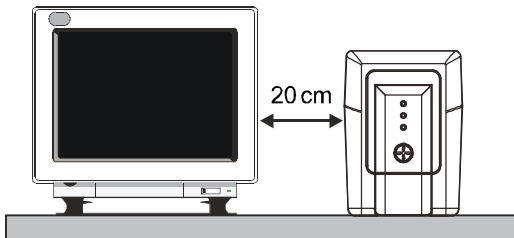

5.3 Charging

The PROTECT A. is supplied with its battery fully charged. Nevertheless, energy may have been lost during transport, so the battery should be fully recharged before it is used for the first time.

Connect the input of the UPS (no. 2 in the figure in chapter 4.3 on page 19) to the mains connection cable provided and plug the mains connector into a suitable shockproof socket. Allow the UPS to charge up for about 8 hours without any load (i.e. without any devices such as computers, monitors, etc. connected to it).

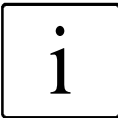
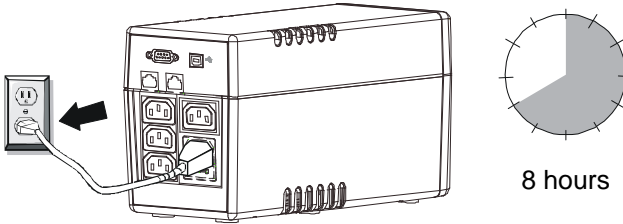

The battery is charged irrespective of the setting of the main switch on the front of the UPS.

5.4 Connecting the Load (e.g. computer)

Connect your loads to the individual UPS backed-up output sockets on the rear of the UPS (chapter 4.3 / no. 1 / pg.19).

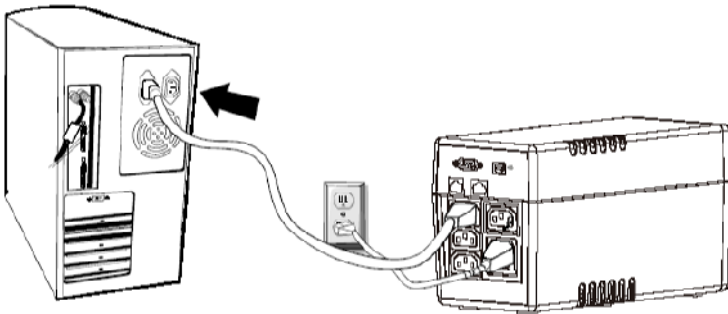

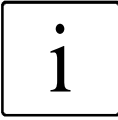

Note that the additional output socket identified in white has a special property (chapter 4.3 / no. 6 / pg.19).

This is always live irrespective of the other outputs. It is not backed up by the UPS, nor can it be switched off using the main switch of the UPS. It is intended for loads that should be protected against overvoltage but do not necessarily need a continued power supply (emergency power) in case of a mains failure. Limit the power to **max. 500 W.**

5.5 Modem/Phone Connection (data line protection)

Connect the incoming phone line into the “IN” connection on the back of the PROTECT A.

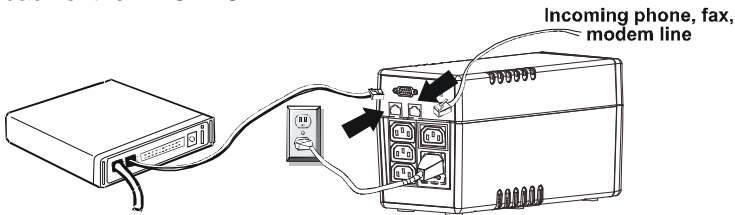

Connect the data terminal unit (phone, fax, modem) to the “OUT” socket.

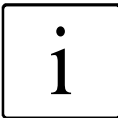

The data line protection has been designed for RJ11 and does not support network cables (RJ45); these should be protected by external measures if necessary.

Data lines are not supplied with the UPS.

5.6 Communication Connection, Connection with USB or Serial Cable

In order to allow unsupervised shutdown of the operating system, connect the RS232 or USB cable as shown in the drawing.

The USB connection is automatically detected.

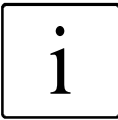
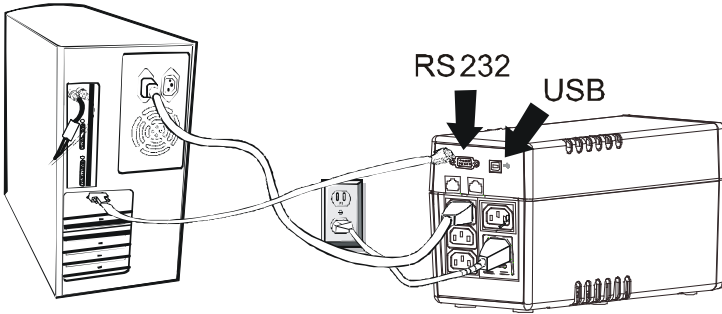

The interfaces are mutually exclusive. There is no provision for simultaneous operation of RS232 and USB.

5.7 Operation

Once you have connected the UPS to a suitable mains connection, you can start operation using the UPS main switch.

Switching ON and OFF:

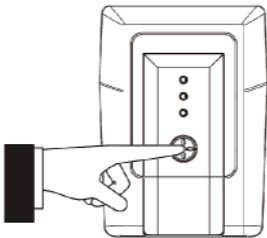

- To switch on, press the main switch on the front of the UPS (chapter 4.3 / no. 1 / pg.19). You must be able to feel this engage in its 2nd position.
- Press the main switch again to switch off the UPS.

Normally, the UPS operates continuously. The UPS now supplies the output with voltage, this being signalled by the green “Normal” LED which lights up permanently (chapter 4.3 / no. 2 / pg. 19).

5.7.1 Normal Operation

During normal operation, i.e. when mains voltage is available, the built-in battery charger keeps the battery fully charged and the mains voltage monitoring system switches the inverter to standby mode.

The connected loads are powered using the monitored and filtered mains voltage, which is additionally stabilised by the integrated A.V.R. control unit. The green "Normal" LED shows that the unit is active.

5.7.2 Battery Operation / Autonomous Operation

When there is a mains failure or if the input voltage moves outside the tolerance range, the inverter automatically switches over to autonomous mode and supplies the loads with voltage from the battery. This drains the capacity of the battery and it is discharged. This status is signalled by the green "Battery" LED flashing as well as an intermittent acoustic signal (chapter 4.3 / no. 2 / pg. 19).

If the UPS does not automatically return to normal operation after a few minutes, close all your work as usual and switch off the loads (e.g. PC) before the battery is fully discharged. This lengthens the service life of the battery! Switch OFF the UPS by pressing the main switch.

During the discharge process as the battery capacity consistently drops, the "Battery" LED flashes, accompanied by an intermittent acoustic signal (once every 10 seconds). The electronics of the UPS switch off the voltage supply of the loads shortly after the battery undervoltage limit is reached ("Battery" LED flashes every second; acoustic signal sounds every second).

Never store the unit in this condition! The discharged battery system should be recharged within a week at the latest.

When the mains voltage comes back, the UPS must be switched on again using the main switch (only applies if it was previously switched off manually), in order to recharge the battery and thus store sufficient battery capacity for any possible future mains failures.

The battery is automatically charged when the mains is present. The battery charging time (to 90% of rated capacity) is about 8 hours after being previously fully discharged.

5.7.3 System Diagnosis / Fault Test

If the monitoring electronics detect an irregularity, the red "Fault" LED is triggered at the same time as an acoustic fault

signal. This might occur because the battery undervoltage limit has been reached, if the temperature has risen too high, or it might indicate that the internal battery system needs to be renewed.



Faults detected and signalled during diagnosis must be rectified, otherwise there is a risk of load voltage loss if a mains failure occurs!

5.7.4 Shutdown and UPS Management Software

The “CompuWatch” software specially developed for these purposes by AEG continuously checks the mains supply and the UPS status.



In conjunction with the “intelligent” UPS, this ensures that the availability of IT components and data security are guaranteed.

The “CompuWatch” shutdown software supports different operating systems, e.g. Windows Linux, Unix, Mac OS X, etc.

Refer to the manual on the CD for details about installing the software on the various operating systems. Other tips and information as well as updates are available from our website at www.AEGpartnerNet.com >> PRODUCTS >> Software >> CompuWatch.

6 Displays and Troubleshooting

6.1 Warning Sounds

Warning sound	Meaning
Sounds every 10 seconds	UPS is operating in battery mode.
Sounds every second	UPS is running in battery mode and will shortly shut down (battery system has reached the battery undervoltage limit).
Sounds every two seconds	Battery system faulty, it may have to be renewed (battery diagnosis negative).
Sounds twice every second	UPS output is overloaded.
Sounds every 2 seconds; continuous warning sound after 50 min	Overload of the step-up/down converter due to UPS overload.
Sustained warning sound	UPS faulty.

6.2 General Troubleshooting and Fault Rectification

Fault	Cause	Solution
No LED display on the front cover plate	Battery missing	Insert the battery and first charge it up for at least 8 hours
	Battery fault	Renew the battery with a battery of the same type
	On/off switch not pressed	Press the switch again
Alarm buzzer sounds continuously with normal AC supply	UPS overload	Check whether the load matches the UPS capacity indicated in the technical data

Data backup time is only very short on power failure	UPS overload	Remove loads that are less important
	Battery voltage is too low	Charge the battery for at least 8 hours
	Battery fault due to high temperature in the operating environment or incorrect treatment of the battery; advanced battery ageing	Renew the battery with a battery of the same type
Mains normal, but "Battery" LED flashes	Fuse blown	De-energise the unit; insert a replacement fuse.
	Mains cable loose	Insert the plug <u>firmly</u> into the non-heating appliance socket of the UPS.
Communication between UPS and computer interrupted	Software is not installed correctly	Check the software settings. Support is available at www.AEGpartnerNet.com
	Cable not connected properly	Check that the RS232/USB cable is firmly connected to the COM or USB port of the computer and confirm the settings again

If you cannot solve the problem that has occurred, stop the entire procedure, switch off the UPS and disconnect the connector from the socket. Please contact our hotline in this case (see page 5).

Please have the serial number of the unit as well as the purchase date at hand. The hotline will provide you with technical support and can inform you about further procedures once you have described the problem.

7 Maintenance

The PROTECT A. consists of state-of-the-art, non-wearing components. We do, however, recommend regular visual checks of the unit to maintain its continuous availability and operational reliability. Check whether:

- ◆ there is any mechanical damage or foreign bodies can be found in the system,
- ◆ any conductive dirt or dust has accumulated in the unit,
- ◆ accumulation of dust affects heat supply and dissipation.



CAUTION:

The PROTECT A. must be disconnected from the power supply prior to carrying out the following work.

If large quantities of dust have accumulated, the unit should, as a precaution, be cleaned with dry compressed air, in order to ensure adequate heat dissipation.

The intervals at which visual checks should be performed are primarily determined by the site conditions.

Checking the battery

Progressive ageing of the battery system can be detected by regular capacity checks. Every 12 months, perform measurements to compare the achievable standby times, e.g. by simulating a mains failure. In this case, the load should always have approximately the same capacity demand. Have the battery system renewed if the time drops drastically compared to the previous measurement.

7.1 Battery Replacement



ATTENTION:

A battery can cause an electric shock, and represents a considerable hazard if handled incorrectly.

The following precautions should be taken before the battery is renewed.

- ◆ Switch off the UPS and disconnect the mains cable from the socket.
- ◆ Remove any rings, wristwatch and other metallic objects you may be wearing.
- ◆ If the replacement battery kit is damaged in any way or shows any signs of leaking, please contact your dealer immediately.
- ◆ Recycle or dispose of the used battery appropriately. Never dispose of batteries by burning. The batteries might explode.



Note:

If you are not qualified to renew the battery, do not try to open the battery cover. Leave this work to qualified personnel.

8 Storage and Disposal

Storage



Long storage times without charging or discharging the battery at regular intervals may lead to permanent damage of the battery.

If the battery is stored at room temperature (20° C to 30° C) it will automatically discharge at a rate of 3-6% per month due to internal reactions. Storing the battery at temperatures above room temperature should be avoided. A high storage temperature also means a higher rate of battery degradation.

Batteries that are stored at room temperature should be recharged every six months to maintain their full capacity and service life.

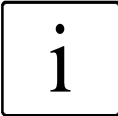

Connect PROTECT A. to the mains before putting it into storage, in order to make sure that the battery is fully charged.

The charging time should be at least 8 hours.

Disposal

In the interest of environmental protection and recycling, please dispose of the individual system components in accordance with the regulations and legal guidelines when permanently taking the system out of operation.

9 List of Terms

9.1 Technical Terminology

AVR	<u>A</u> utomatic <u>V</u> oltage <u>R</u> egulation Automatic voltage regulation against mains voltage deviations
DC/DC booster	Circuit technology for increasing a DC voltage to a higher voltage level
EPO	<u>E</u> mergency <u>P</u> ower <u>O</u> ff Device for emergency shutdown
PFC	<u>P</u> ower <u>F</u> actor <u>C</u> orrection Circuit technology for minimising system disturbances (particularly important when connecting non-linear loads)
Appliance protection	Term from overvoltage technology Classic mains overvoltage protection consists of a lightning surge arrester (Class B), overvoltage protection (Class C) and, finally, what is referred to as appliance protection (Class D) – see also http://www.phoenixcontact.de (“TRABTECH” topic) for example
Class D	See appliance protection
LED	<u>L</u> ight <u>E</u> mitting <u>D</u> iode Electronic semi-conductor component, commonly referred to as an LED, used for optical signalling.
SNMP	<u>S</u> imple <u>N</u> etwork <u>M</u> anagement <u>P</u> rotocol A protocol encountered frequently in networks for managing / handling components
VFD	<u>O</u> utput <u>V</u> oltage and <u>F</u> requency <u>D</u> ependent from mains supply The UPS output is dependent on mains voltage and frequency fluctuations. Earlier designation: OFFLINE
VI	<u>O</u> utput <u>V</u> oltage <u>I</u> ndependent from mains supply The UPS output is dependent on mains frequency fluctuations, but the mains voltage is prepared by electronic / passive voltage control units. Earlier designation: LINE-INTERACTIVE
VFI	<u>O</u> utput <u>V</u> oltage and <u>F</u> requency <u>I</u> ndependent from mains supply The UPS output is independent from mains voltage and frequency fluctuations. Earlier designation: ONLINE

Guarantee Certificate

Type:

Unit
number:.....

Date of
purchase:.....

Dealer stamp / signature

Errors and changes excepted.

AEG

Power Solutions

AEG Power Solutions GmbH

Emil-Siepmann-Straße 32

59581 Warstein-Belecke

Germany

Operating instructions

BAL 8000024070 EN